

Kadeca Wine Chiller

INSTRUCTION MANUAL

Model Number: KA143T & KA165T



KA143T



KA165T

BEFORE USE, PLEASE READ AND FOLLOW ALL SAFETY RULES AND OPERATING INSTRUCTIONS.

Thank you for choosing wine Chiller Kadeca!

WE HOPE THIS PRODUCT WILL SATISFY YOUR REQUIREMENTS IN LONG TIME!

PARTS & FEATURES

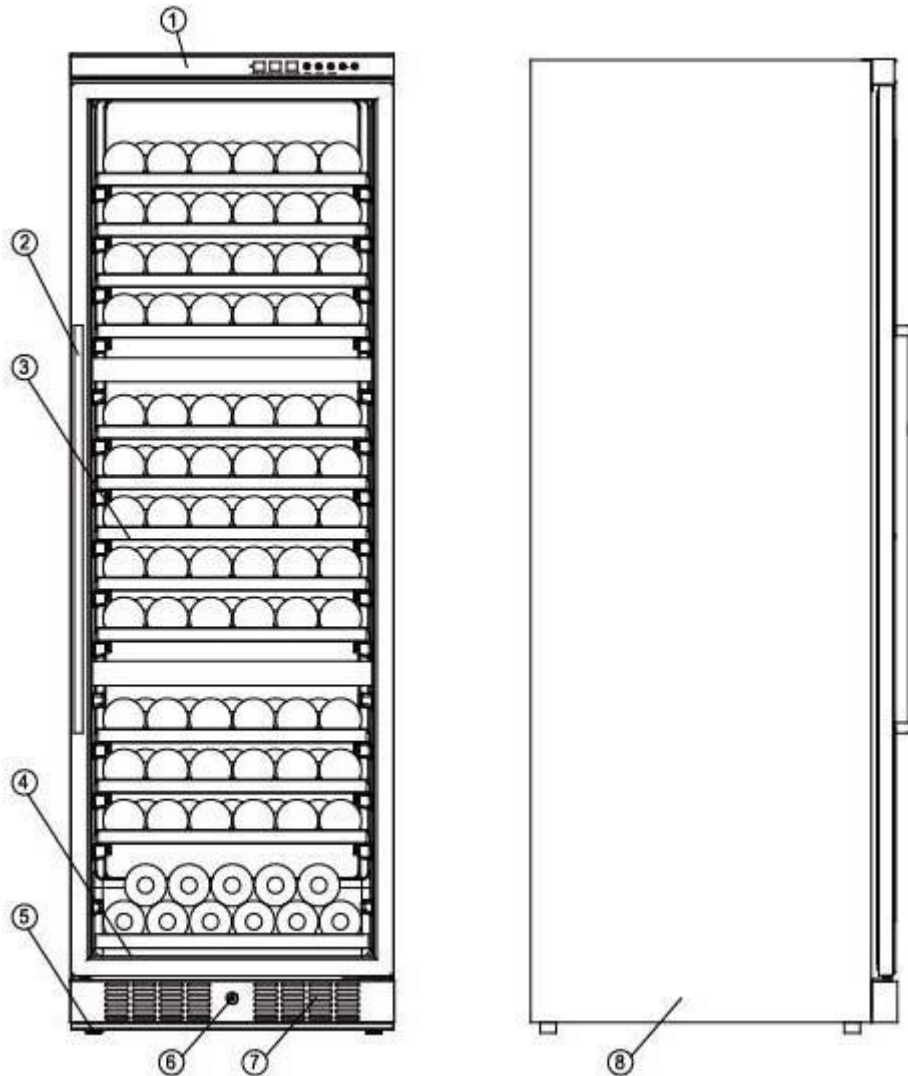

1. DIGITAL CONTROL PANEL
2. STAINLESS STEEL HANDLE
3. LARGE SHELVES
4. SMALL BOTTOM SHELF

5. LEVELING LEGS
6. SECURITY LOCK
7. BOTTOM GRILLE
8. CABINET

WARNING

- To prevent damaging the door gasket, make sure to have the door all the way opened when pulling shelves out of the rail compartment.
- The appliance must be positioned so that the plug is accessible. Release the electric cord. Move your cabinet to its final location. Do not move your Cabinet while loaded with wine. You might distort the body. The Wine Chiller should be installed in a suitable place in order to avoid Touching the compressor with the hand.
- If the supply cord is damaged, it must be replaced by manufacturer of its Service agent or a similarly qualified person in order to avoid a hazard.

IMPORTANT SAFETY INSTRUCTIONS

⚡WARNING⚡

To reduce the risk of fire, electrical shock, or injury when using your appliance, follow these basic precautions:

- Read all instructions before using the Wine Chiller.
- **DANGER or WARNING:** Risk of child entrapment.
Child entrapment and suffocation are not problems of the past. Junked or abandoned appliances are still dangerous . . . even if they will “just sit in the garage a few days”.
- **Before you throw away your old Wine Chiller:** Take off the door. Leave the shelves in place so that children may not easily climb inside.
- Never allow children to operate, play with, or crawl inside the appliance.
- Never clean appliance parts with flammable fluids. The fumes can create a fire hazard or explosion.
- Do not store or use gasoline or any other flammable vapors and liquids in the vicinity of this or any other appliance. The fumes can create a fire hazard or explosion.

-Save these instructions-

INSTALLATION INSTRUCTIONS

➤ Before Using Your Wine Chiller

- Remove the exterior and interior packing.
- Before connecting the Wine Chiller to the power source, let it stand upright for approximately 2 hours. This will reduce the possibility of a malfunction in the cooling system from handling during transportation.
- Clean the interior surface with lukewarm water using a soft cloth.
- Install the handle on the left side of the door.
- When replace the illuminating lamp, please select the lamp which comply with the rated power input of lamp according to the rating label. Shut off the power supply before replacing the lamp.
- When disposing your appliance, please choose an authorized disposal site.

➤ Installation of Your Wine Chiller

- This appliance is designed to be for free standing installation or built-in.
- Place your Wine Chiller on a floor that is strong enough to support it when it is fully loaded. To level your Wine Chiller, adjust the front leveling leg at the bottom of the Wine Chiller.
- Locate the Wine Chiller away from direct sunlight and sources of heat (stove, heater, radiator, etc.). Direct sunlight may affect the acrylic coating and heat sources may increase electrical consumption. Extreme cold ambient temperatures may also cause the unit not to perform properly.
- Avoid locating the unit in moist areas.
- Plug the Wine Chiller into an exclusive, properly installed-grounded wall outlet. Do not under any circumstances cut or remove the third (ground) prong from the power cord. Any questions concerning power and/or grounding should be directed toward a certified electrician or an authorized Products service center.

OPERATING YOUR WINE CHILLER

The Wine Chiller should be placed in where the ambient temperature is between 32-95 degrees Fahrenheit(0-35°C). If the ambient temperature is above or below this range, the performance of the unit may be affected. For example, placing your unit in extreme cold or hot conditions may cause interior temperatures to fluctuate. The range of setting temperatures may not be reached.

KA143T

The above temperatures may fluctuate depending on whether or not the interior bulb is ON or OFF or whether the bottles are located on the upper/middle or lower section.

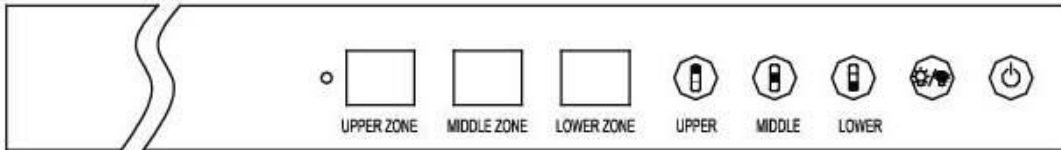

➤ ON/OFF Power and memory function

To turn the Wine chiller ON or OFF, press and hold the power button for 2 seconds. The LED readout will show the last set temperature.

➤ Setting the Temperature Control

- Each cooling compartment of the Wine Chillers (upper middle & lower) is independently controlled. To set the temperature:
Connect the power cord to a properly grounded outlet. In the event of a power interruption, each compartment will default to the last temperature setting.
- Set the desired cooling temperature by pressing the buttons adjacent to the “upper/middle/lower” program. Each depression of the buttons will scroll through the available temperature settings (for each compartment) in decreases of 1 degree. The temperature selected will flash in the LED display for approximately 5 seconds, then revert back to display the temperature of the internal cabinet

Upper compartment: The temperature setting can be adjusted from 5°C to 18°C (40°F to 64°F).

Middle compartment: The temperature setting can be adjusted from 5°C to 12°C (40°F to 54°F).

Lower compartment: The temperature setting can be adjusted from 12°C to 18°C (54°F to 64°F).

- To view the “set” temperature. (anytime) press and hold the corresponding button for approximately 5 seconds, the “set” temperature will temporarily “flash” in the LED display for 5 seconds.

NOTE:

- If the unit is unplugged, power lost, or turned off, you must wait 3 to 5 minutes before restarting the unit. If you attempt to restart before this time delay, the Wine Chiller will not start.
- When you use the Wine Chiller for the first time or restart the Wine Chiller after having been shut off for a long time, there could be a few degrees variance between the temperature you select and the one indicated on the LED readout. This is normal and it is due to the length of the activation time. Once the Wine Chiller is running for a few hours everything will be back to normal.

KA165T

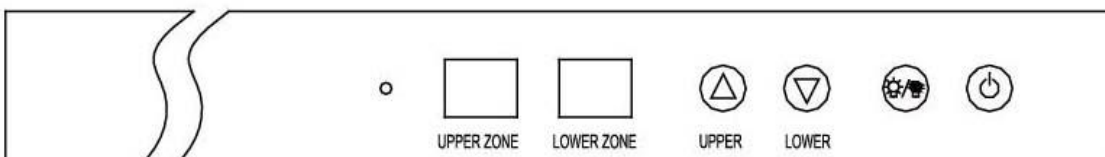

➤ ON/OFF Power and memory function

To turn the Wine chiller ON or OFF, press and hold the power button for 2 seconds. The LED readout will show the last set temperature.

➤ Setting the Temperature Control

- Each cooling compartment of the Wine Chillers (upper & lower) is independently controlled. To set

the temperature:

Connect the power cord to a properly grounded outlet. In the event of a power interruption, each compartment will default to the last temperature setting.



- Set the desired cooling temperature by pressing the buttons adjacent to the “upper /lower” program. Each depression of the buttons will scroll through the available temperature settings (for each compartment) in decreases of 1 degree. The temperature selected will flash in the LED display for approximately 5 seconds, then revert back to display the temperature of the internal cabinet

Upper compartment: The temperature setting can be adjusted from 5°C to 18°C (40°F to 64°F).

Lower compartment: The temperature setting can be adjusted from 5°C to 18°C (40°F to 64°F).

- To view the “set” temperature. (anytime) press and hold the corresponding button for approximately 5 seconds, the “set” temperature will temporarily “flash” in the LED display for 5 seconds.

➤ **Interior Light**

You can turn the interior light ON or OFF by pushing the button marked with the “bulb” symbol / .

➤ **Door Lock**

Your unit is provided with a lock and key combination.

The keys are located inside the plastic bag that contains the User’s Guide. Insert the key into the lock and turn it counterclockwise to unlock the door. To lock the door do the reverse operation making sure metal pin is engaged completely. Remove the key and place it in a secure place for safekeeping.

CARE AND MAINTENANCE

➤ **How to remove the shelf**

Put the shelf gap(left and right) under the square plastic block, up tilt the shelf, then pull the shelf from the Wine Chiller.

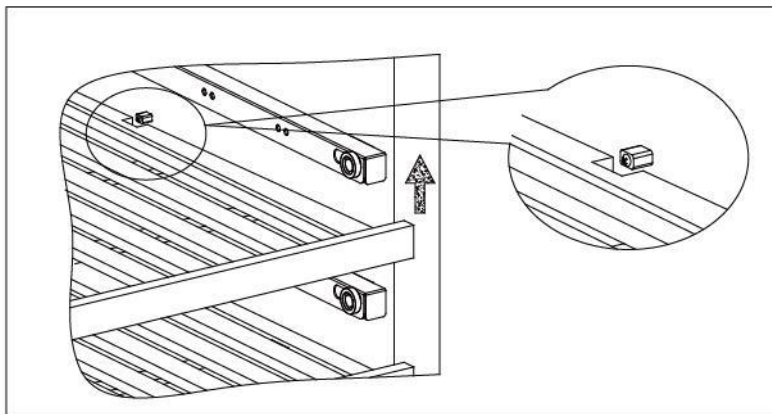

➤ **Cleaning Your Wine Chiller**

- Turn off the power, unplug the appliance, and remove all items including shelves and rack.
- Wash the inside surfaces with a warm water and baking soda solution. The solution should be about 2 tablespoons of baking soda to a quart of water.
- Wash the shelves with a mild detergent solution.
- Wring excess water out of the sponge or cloth when cleaning area of the controls, or any electrical parts.
- Wash the outside cabinet with warm water and mild liquid detergent. Rinse well and wipe dry with a clean soft cloth.

➤ **Power Failure**

- Most power failures are corrected within a few hours and should not affect the temperature of your appliance if you minimize the number of times the door is opened. If the power is going to be off for a longer period of time, you need to take the proper steps to protect your contents.

➤ **Vacation Time**

- **Short vacations:** Leave the Wine Chiller operating during vacations of less than three weeks.
- **Long vacations:** If the appliance will not be used for several months, remove all items and turn off the appliance. Clean and dry the interior thoroughly. To prevent odor and mold growth, leave the door open slightly: blocking it open if necessary.

➤ **Moving Your Wine Chiller**

- Remove all items.
- Securely tape down all loose items (shelves) inside your appliance.
- Turn the adjustable leg up to the base to avoid damage.
- Tape the door shut.
- Be sure the appliance stays secure in the upright position during transportation. Also protect outside of appliance with a blanket, or similar item.

➤ **Energy Saving Tips**

- The Wine Chiller should be located in the coolest area of the room, away from heat producing appliances, and out of the direct sunlight.

➤ **Humidor Instructions**

If humidity conditions are low within either of the compartments, it will be necessary to use the humidor. Fill the humidor about 3/4 full with fresh water, and place the humidor on the bottom shelf. Check the water level occasionally and refill as necessary.

NOTE: The use of the “humidor(s)” will reduce the storage capacity of the bottom rack(s) by one bottle.

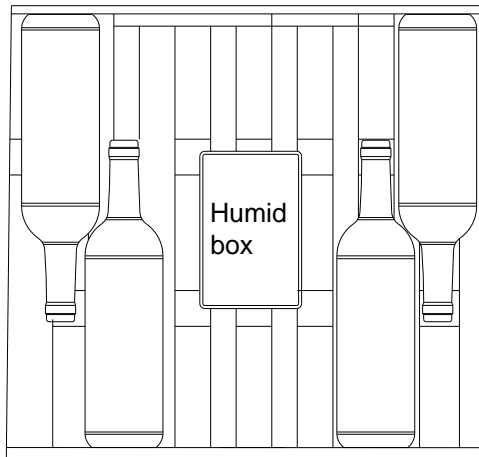

➤ **Odour Filter**

The Odour Filter can purify air and eliminate peculiar smell, especially decompose formaldehyde and toxicant from air.

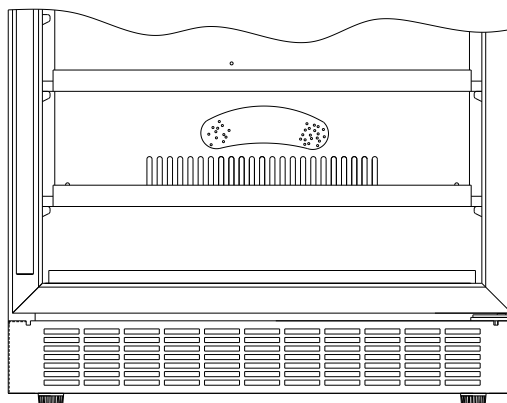

PROBLEMS WITH YOUR WINE CHILLER?

You can solve many common Wine Chiller problems easily, saving you the cost of a possible service call. Try the suggestions below to see if you can solve the problem before calling the servicer.

TROUBLESHOOTING GUIDE

PROBLEM	POSSIBLE CAUSE
Wine Chiller does not operate.	Not plugged in. The appliance is turned off. The circuit breaker tripped or a blown fuse.
Wine Chiller is not cold enough.	Check the temperature control setting. External environment may require a higher setting. The door is opened too often. The door is not closed completely. The door gasket does not seal properly.
Turns on and off frequently.	The room temperature is hotter than normal. A large amount of contents has been added to the Wine Chiller. The door is opened too often. The door is not closed completely. The temperature control is not set correctly. The door gasket does not seal properly.
The light does not work.	Not plugged in. The circuit breaker tripped or a blown fuse. The bulb has burned out. The light button is "OFF".
Vibrations.	Check to assure that the Wine Chiller is level.
The Wine Chiller seems to make too much noise.	The rattling noise may come from the flow of the refrigerant, which is normal. As each cycle ends, you may hear gurgling sounds caused by the flow of refrigerant in your Wine Chiller. Contraction and expansion of the inside walls may cause popping and crackling noises. The Wine Chiller is not level.
The door will not close properly.	The Wine Chiller is not level. The door was reversed and not properly installed. The gasket is dirty. The shelves are out of position.
Water condensation may form on the glass door.	A natural occurrence due to high humidity ambient . Just wipe it off.

Specifications

Model	KA143T	KA165T
Voltage	220-240V	220-240V
Rated frequency	50 Hz	50 Hz
Rated power input	190W	190W
Electric current	1.2A	1.2A
Classification of climate	T	T
Net weight	105 Kg	105 Kg
Net capacity	404	413
Dimension	595*675*1803mm	595*675*1803mm

Specifications are subject to change without prior notice.